

# UltraFlo™

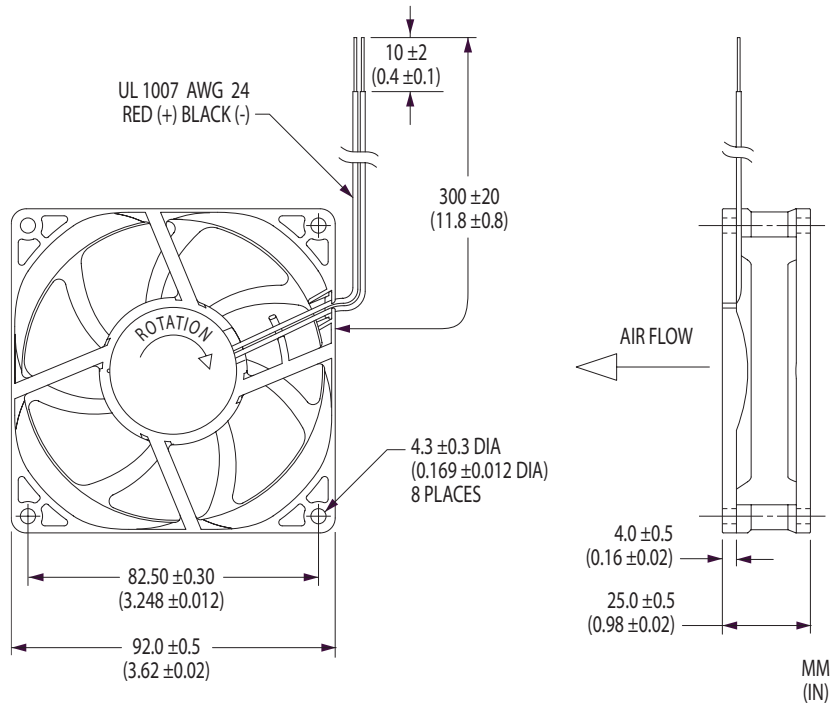

## T92T Series

- ✓ Durable, Magnetically Stabilized NBRX Sleeve Bearing Design
- ✓ Current-Limit Protection
- ✓ Optional Open-Collector Tachometer or Locked Rotor Alarm
- ✓ Plastic Housing and Impeller Rated V-0
- ✓ 12V and 24V Models



## 92x25mm Tube Axial Cooling Fans

| Model         | Air Flow<br>(CFM) | Max. Static<br>Pressure<br>(inwg) | Operating Voltage |              | Operating<br>Current<br>(A) | Input<br>Power<br>(W) | Fan<br>Speed<br>(rpm) | Sound<br>Pressure<br>(dBA) | Operating Temp. |              | L10<br>Life†<br>(hours) |
|---------------|-------------------|-----------------------------------|-------------------|--------------|-----------------------------|-----------------------|-----------------------|----------------------------|-----------------|--------------|-------------------------|
|               |                   |                                   | Nominal<br>(V)    | Range<br>(V) |                             |                       |                       |                            | Min.<br>(°C)    | Max.<br>(°C) |                         |
| T92T12MUA7-51 | 52                | 0.18                              | 12                | 7.0-13.8     | 0.25                        | 3.0                   | 3100                  | 32.0                       | -10             | +70          | 45,000                  |
| T92T24MUA7-51 | 52                | 0.18                              | 24                | 10.0-27.6    | 0.14                        | 3.4                   | 3100                  | 32.0                       | -10             | +70          | 45,000                  |
| T92T12MGA7-51 | 45                | 0.15                              | 12                | 7.0-13.8     | 0.18                        | 2.2                   | 2700                  | 29.0                       | -10             | +70          | —                       |
| T92T24MGA7-51 | 45                | 0.15                              | 24                | 10.0-27.6    | 0.10                        | 2.4                   | 2700                  | 29.0                       | -10             | +70          | —                       |
| T92T12MHA7-51 | 40                | 0.12                              | 12                | 7.0-13.8     | 0.14                        | 1.7                   | 2400                  | 25.0                       | -10             | +70          | —                       |
| T92T24MHA7-51 | 40                | 0.12                              | 24                | 10.0-27.6    | 0.08                        | 1.9                   | 2400                  | 25.0                       | -10             | +70          | —                       |
| T92T12MMA7-51 | 34                | 0.09                              | 12                | 7.0-13.8     | 0.10                        | 1.2                   | 2050                  | 19.5                       | -10             | +70          | —                       |
| T92T24MMA7-51 | 34                | 0.09                              | 24                | 10.0-27.6    | 0.05                        | 1.2                   | 2050                  | 19.5                       | -10             | +70          | —                       |

Air flow, current, speed and sound pressure ratings are at nominal operating voltage and zero static pressure. Current and power ratings are average expected values under those conditions. † L10 bearing life expectancy at  $T_A = +40^\circ\text{C}$ .™ UltraFlo is a brand trademark of Nidec Corporation. N/AJAB

### Recommended Standard Connectors

| Connector Pitch | Manufacturer | Housing*         | Contacts          |
|-----------------|--------------|------------------|-------------------|
| 1.50 mm         | J.S.T.       | ZHR- <i>n</i>    | SHZ-002T-P0.5     |
| 2.00 mm         | J.S.T.       | PHR- <i>n</i>    | SPH-002T-P0.5S    |
|                 | Tyco/AMP     | 173977- <i>n</i> | Includes Contacts |
| 2.50 mm         | J.S.T.       | EHR- <i>n</i>    | SEH-001T-P0.6     |
|                 | J.S.T.       | XHP- <i>n</i>    | SXH-001T-P0.6     |
|                 | Tyco/AMP     | 171822- <i>n</i> | Includes Contacts |
| 2.54 mm         | Molex        | 2695             | 5159              |

\* The character "*n*" shown at the end of housing model names represents the number of contact positions available with that housing. ZHR-2, for example, identifies a housing with two contact positions.

All for dreams

Nidec America Corporation · phone 781-848-0970 · email fans@nidec.com · www.nidec.com

T92T Tube Axial Fans

# UltraFlo

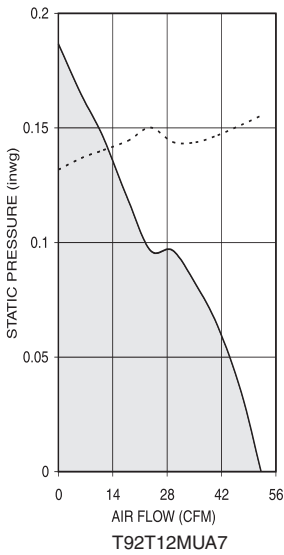

T92T12MUA7

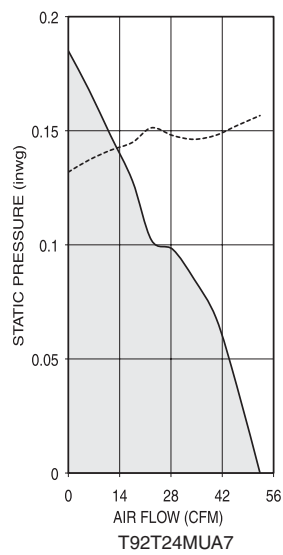

T92T24MUA7

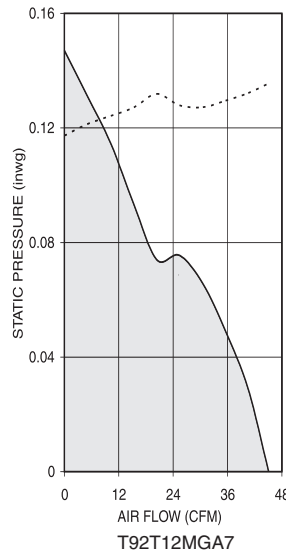

T92T12MGA7

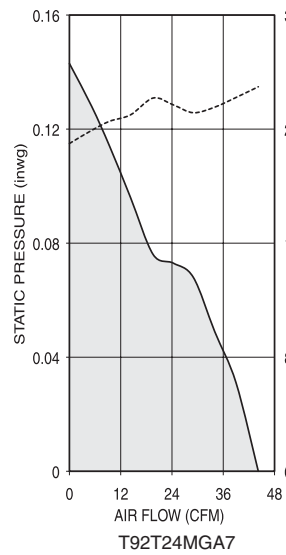

T92T24MGA7

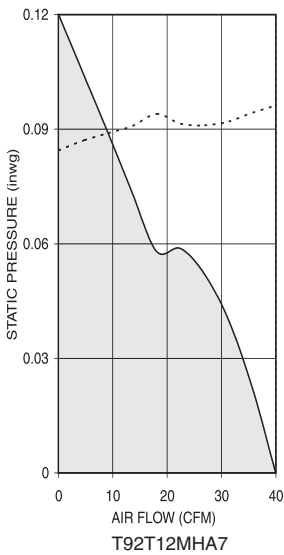

T92T12MHA7

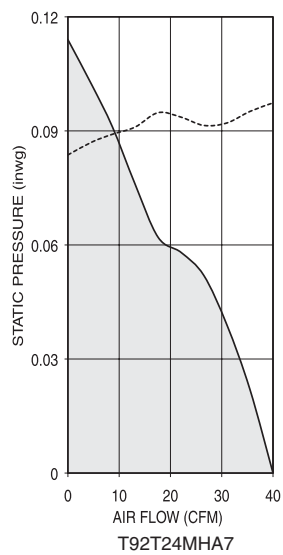

T92T24MHA7

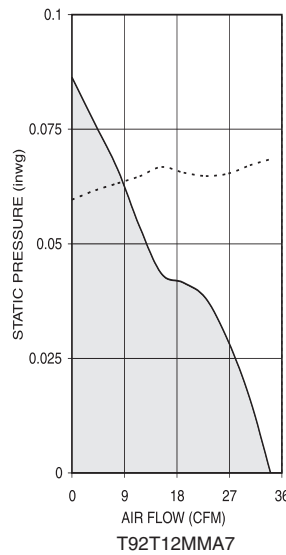

T92T12MMA7

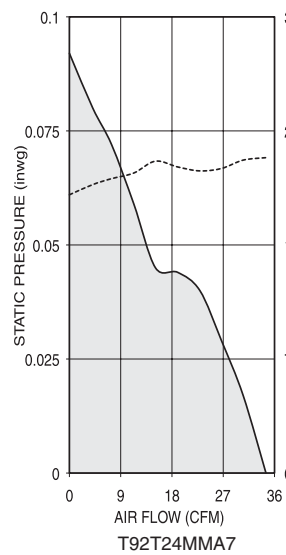

T92T24MMA7

## OPEN-COLLECTOR TACHOMETER

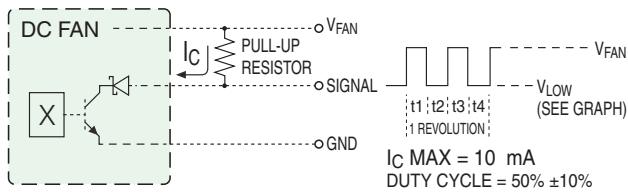

Option '-52'

## TYPICAL VALUES OF $V_{LOW}$ AS A FUNCTION OF $I_C$

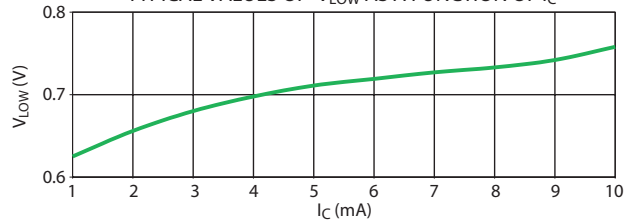

## OPEN-COLLECTOR LOCKED ROTOR ALARM

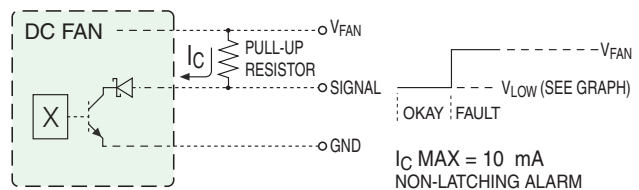

Option '-53'



All for dreams

Nidec America Corporation · phone 781-848-0970 · email fans@nidec.com · www.nidec.com